

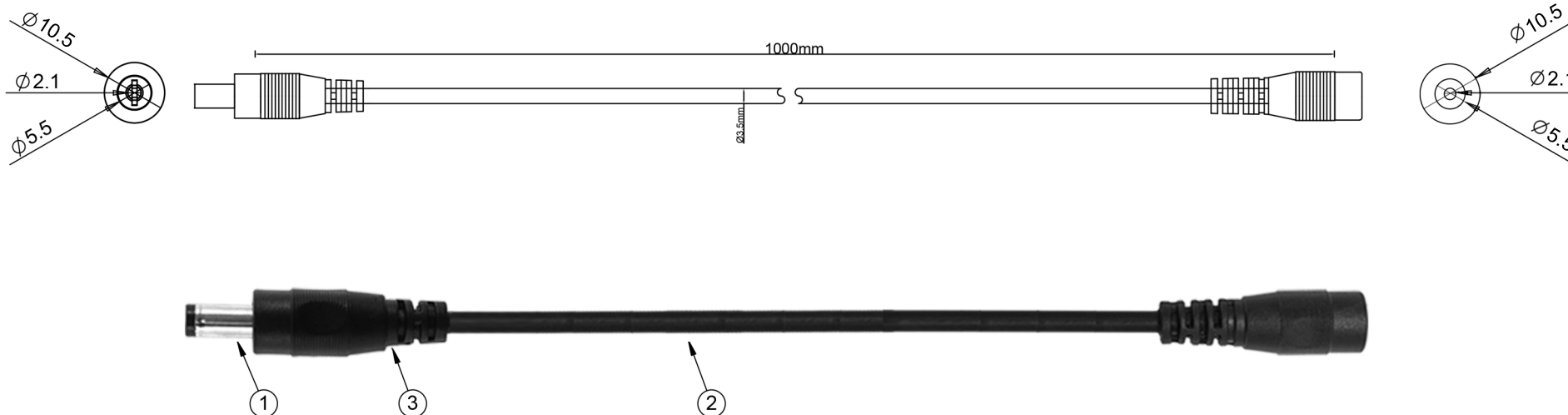

ITEM NO.	PART NUMBER	DESCRIPTION	QTY.	COMPONENT NOTES
1	50-00024	Connector, dc plug, 5.5x2.1xL23 mm, molding style, spring contacts	1	
2	30-00683	Wire, 2C TS, 22 AWG, UL2464 , 300V, 80C, 5.2 mm, VW-1, PVC	1	
3	24-00182	Overmold, dc plug, 5.5 mm, DCpowercord	1	black



Notes:
Functionally equivalent components may be substituted

Electrical requirements: 3 A, 12 Vdc

Wiring Diagram	
50-00024	wire color
center	red
sleeve	black

Revision:	Date:	Description:	Prepared:	Notes:	 tel +86-0755-85271922 web dcpowercord.com
A	12/3/2021	DCpowercord release	DN <small>Digitally signed by DN Date: 2021.11.30 13:35:59 +08'00'</small>	RoHS compliant	
			Verified: PS <small>Digitally signed by PS Date: 2021.11.30 15:41:28 +08'00'</small>	Function test: no open, no short circuit, no intermittent	
			Dimensions are in millimeters. Tolerances: X: ± 0.5 mm X.X: ± 0.3 mm X.XX: ± 0.05 mm	Description: Cable, 1000mm, 5.5x2.1x10.5mm 50-00024 dc power extension cable, 22 AWG, 30-00683 wire	
			Size:	Part number:	
			A	01-2210B	
			Scale: 1:1		Sheet 1 of 1